

WORKSHOP GARAGE

A-FRAME

10', 12', 14' WIDE

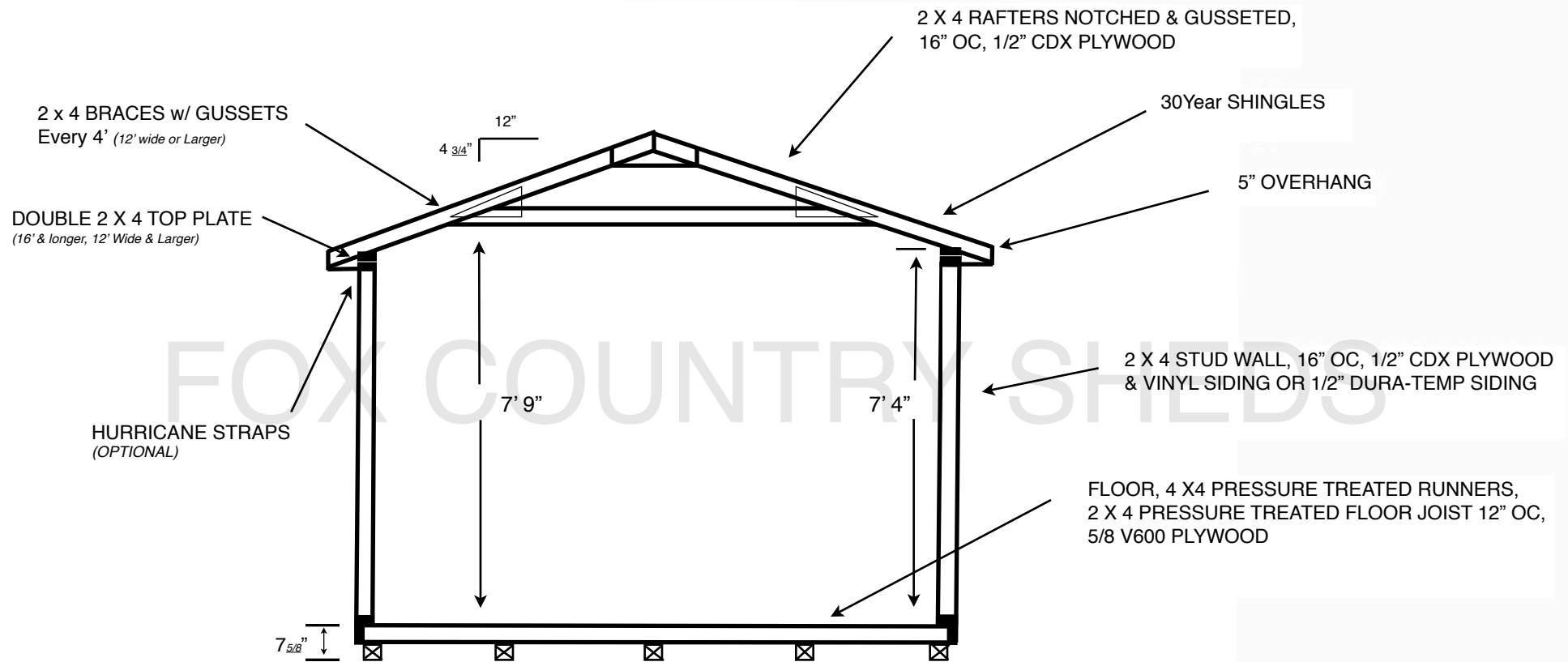

CROSS SECTION

Ground to Peak Heights		
12' Wide	14' Wide	16' Wide
128"	131"	135"



537 E. 28th Division Hwy
Lititz, Pa 17543
717-626-9560 Fax: 717-626-7810

WORKSHOP GARAGE

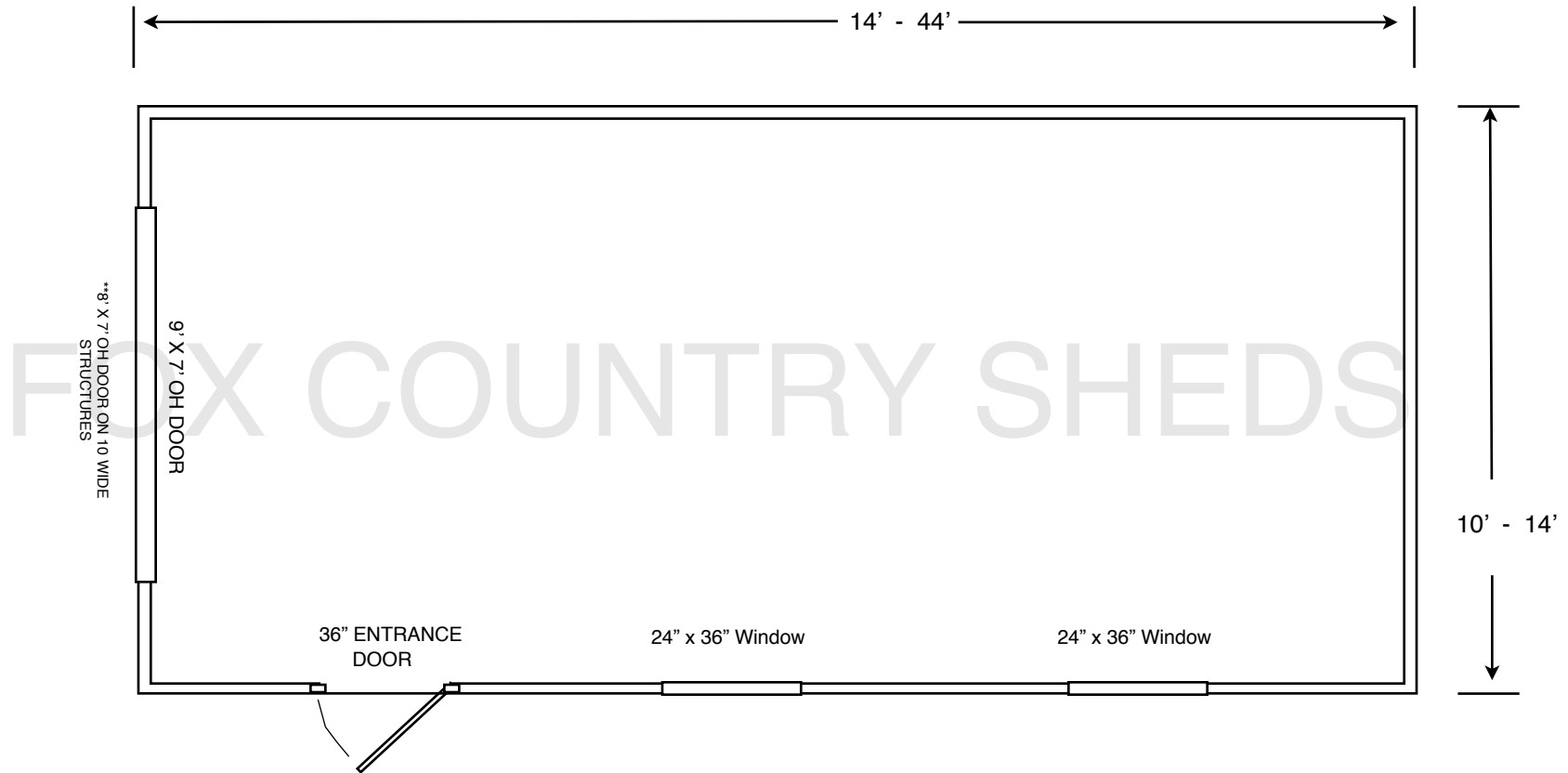

FLOOR PLAN

Side View

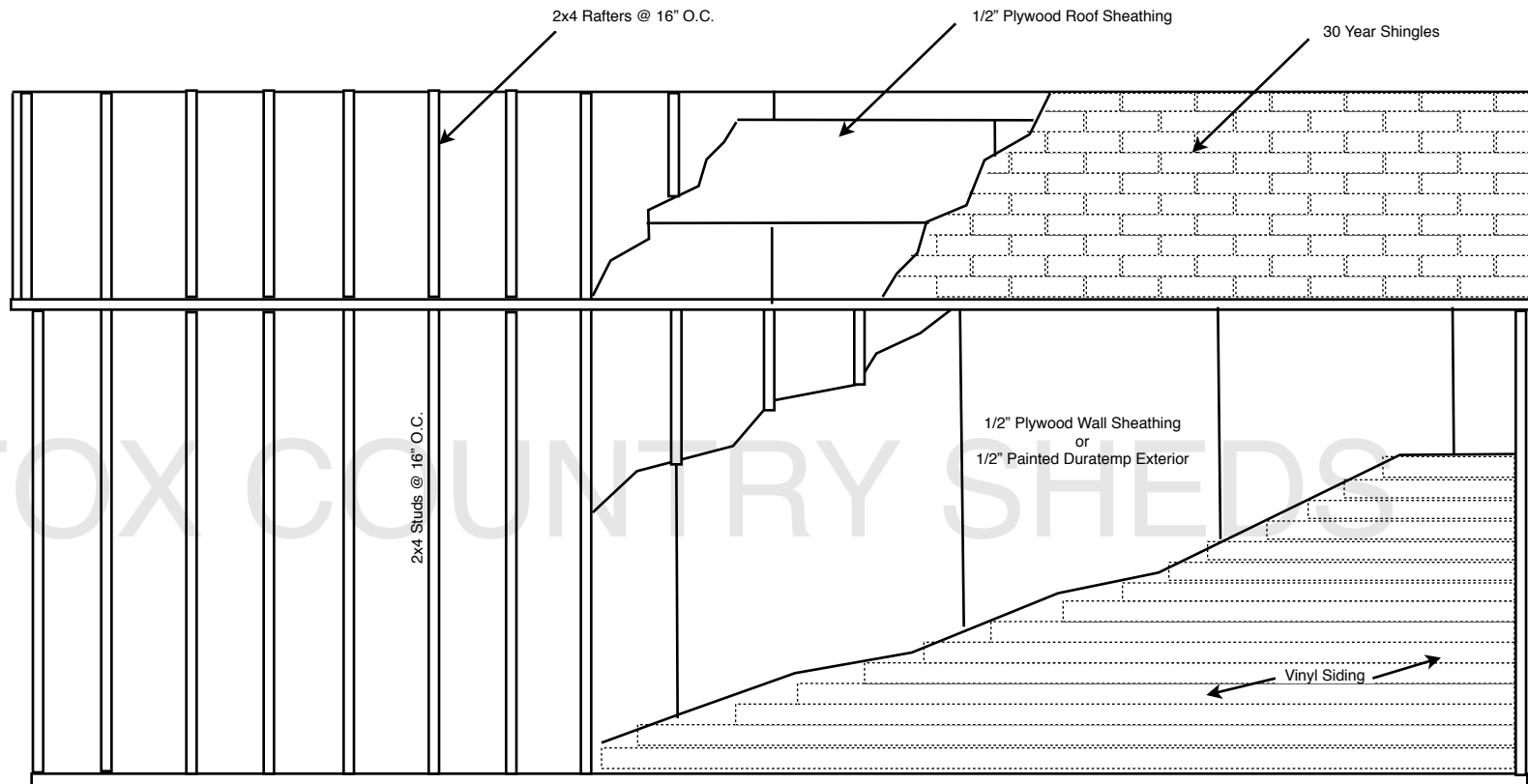



537 E. 28th Division Hwy
Lititz, Pa 17543
717-626-9560 Fax: 717-626-7810

Side View

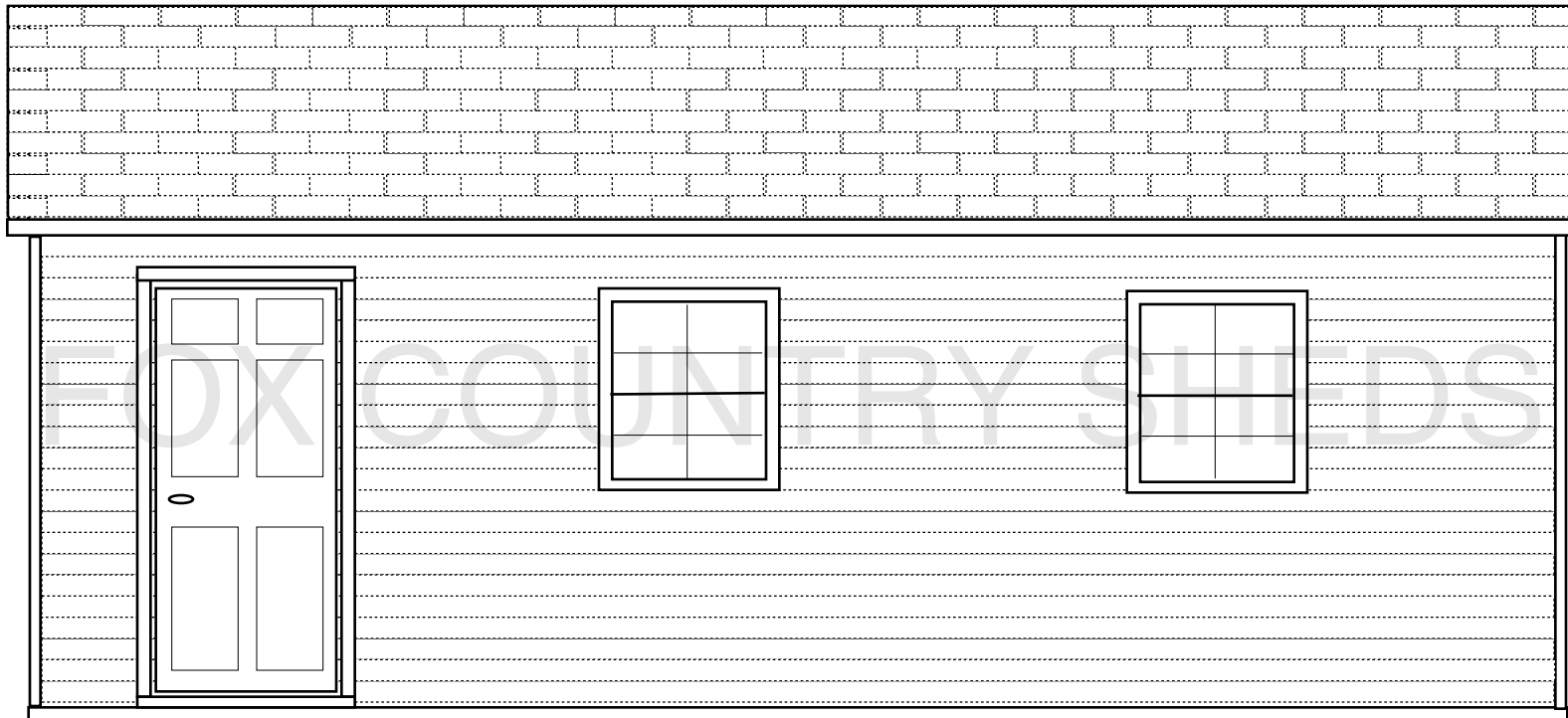

← 14' - 44' →

Front View

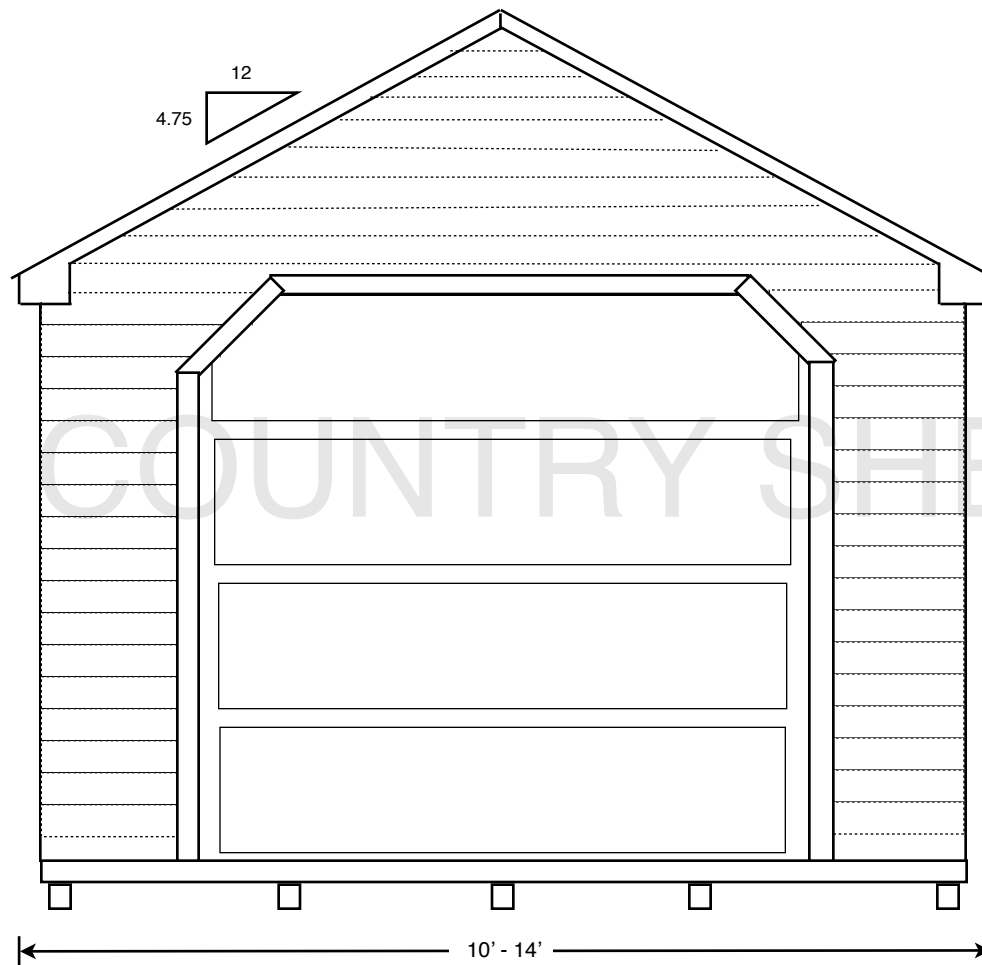

FOX COUNTRY SHEDS



4 X 4 RUNNER SPACING

8' WIDE

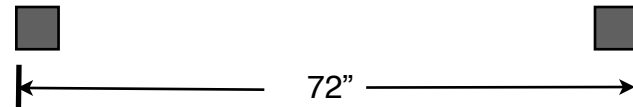

10' WIDE

Middle Runner is Centered

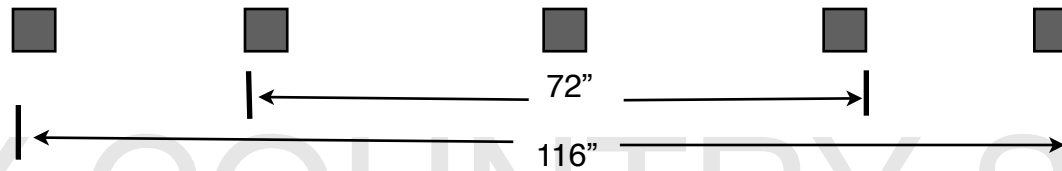

12' WIDE

Middle Runner is Centered

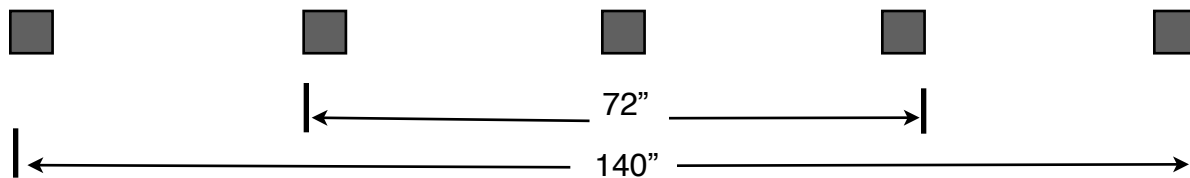

*13'6" Structure subtract 3" off last two runners

14' WIDE

Middle Runner is Centered

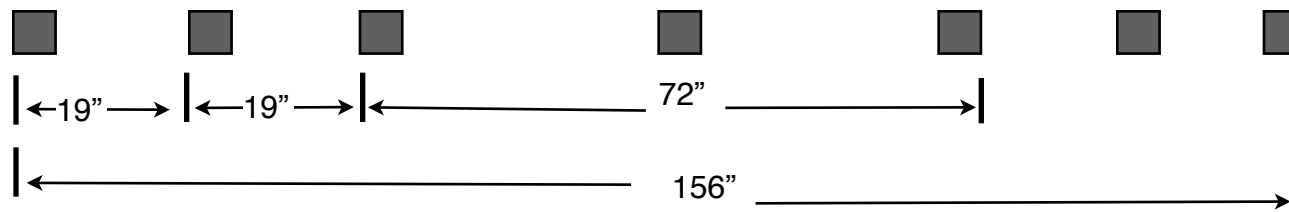



537 E. 28th Division Hwy
Lititz, Pa 17543
717-626-9560 Fax: 717-626-7810

Painted Dura-Temp Shed

